

HIRTH TOOLS

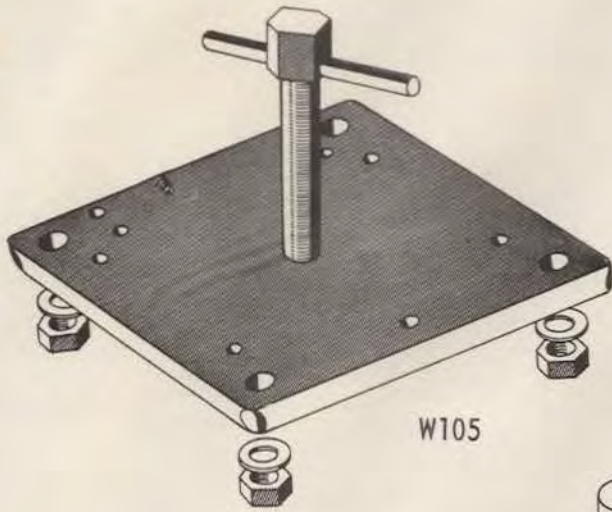

W105

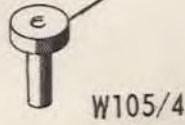

W105/4

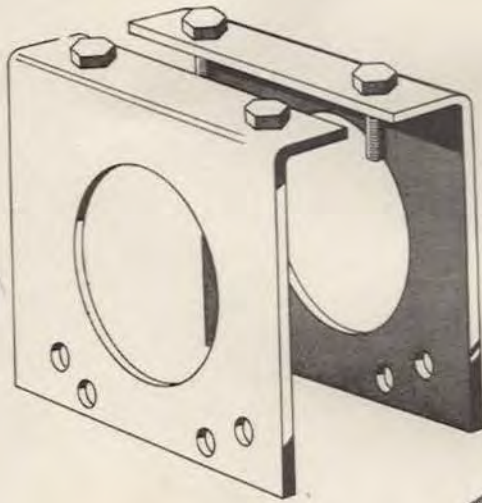
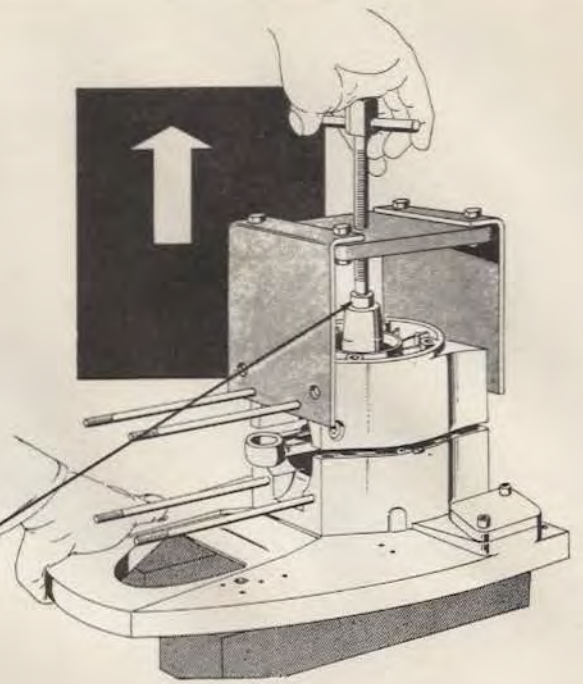

W105/5

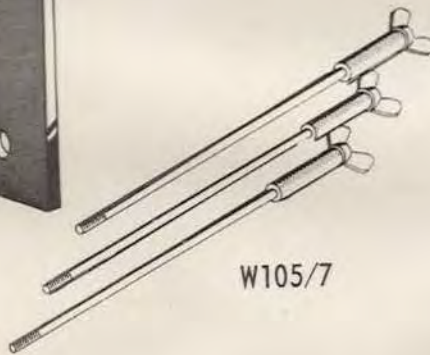

W105/7

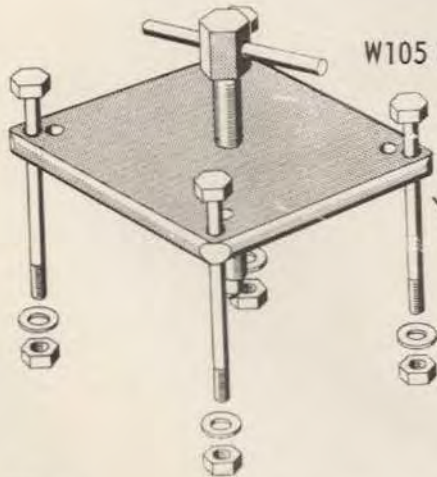
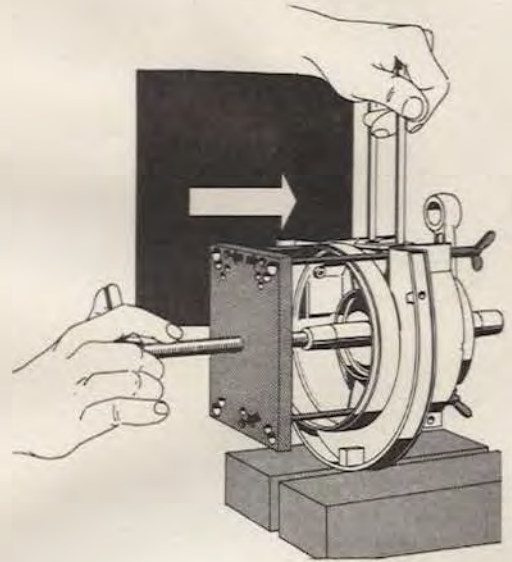

W105 (with 4 Hex. Screws, DIN 931 M 10 x 120)



W105/3

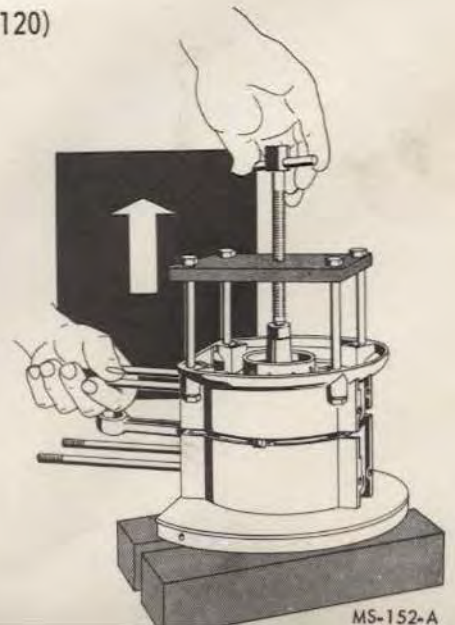
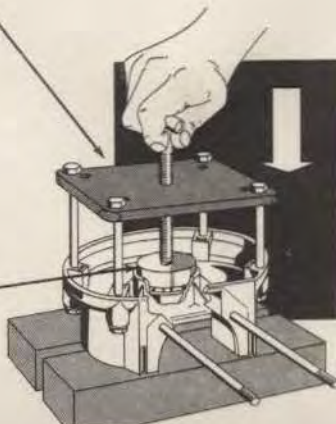

HIRTH TOOLS



W112

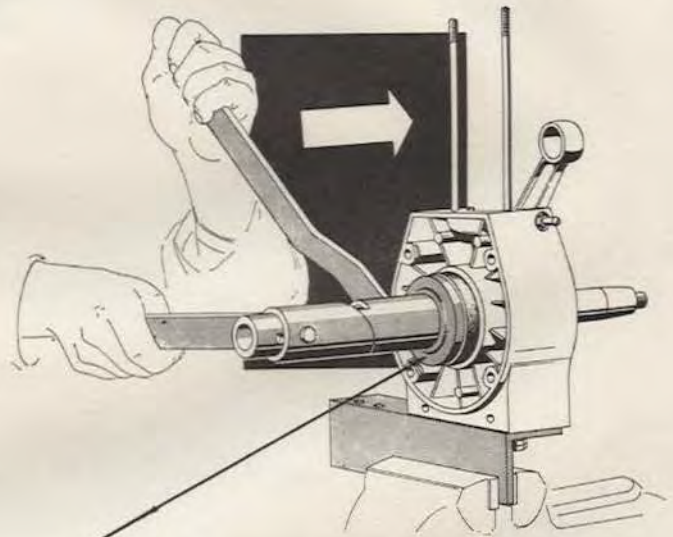
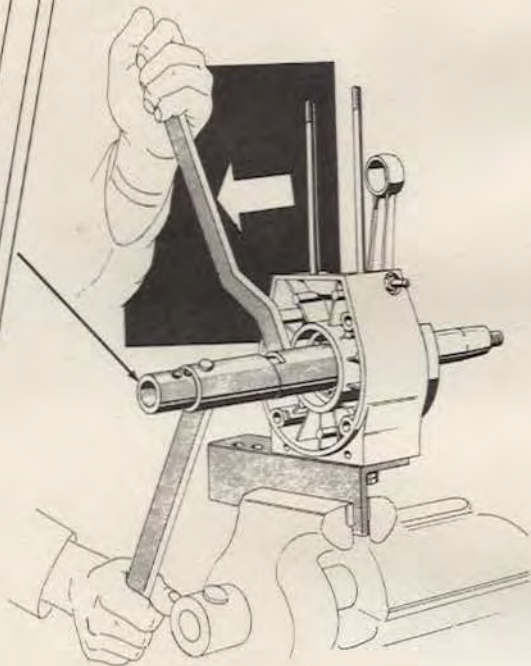
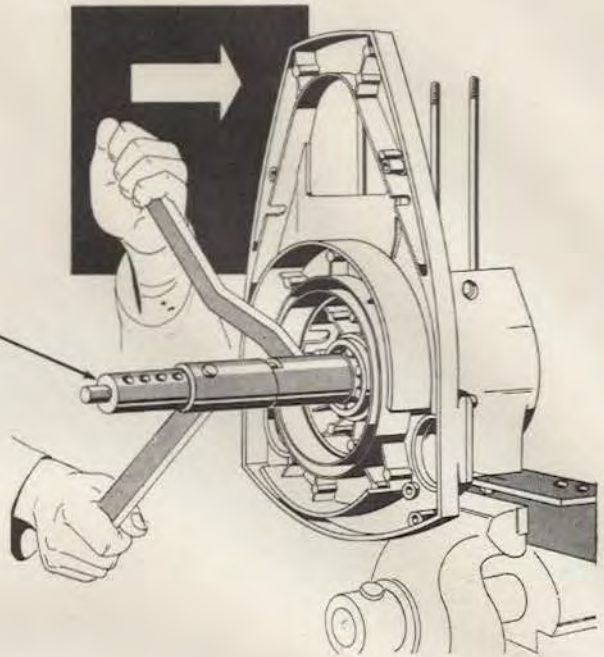

W37/8



W114



W23

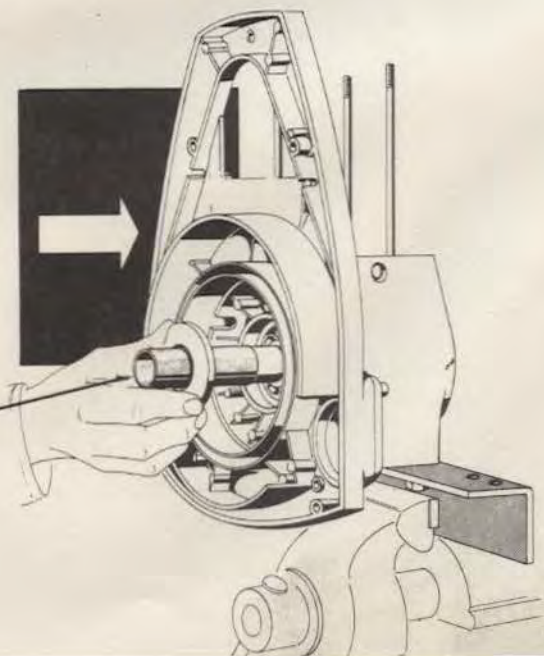

HIRTH TOOLS

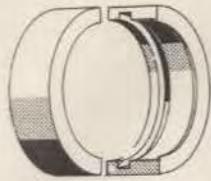

W107/14

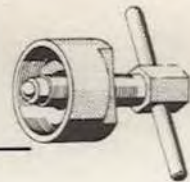
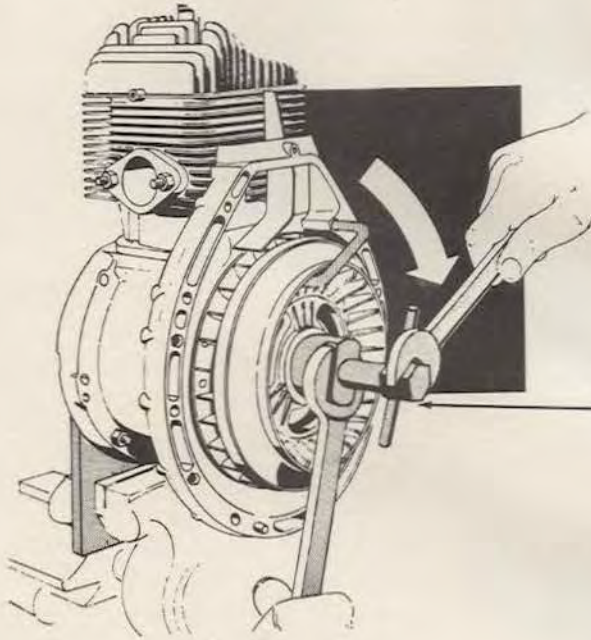
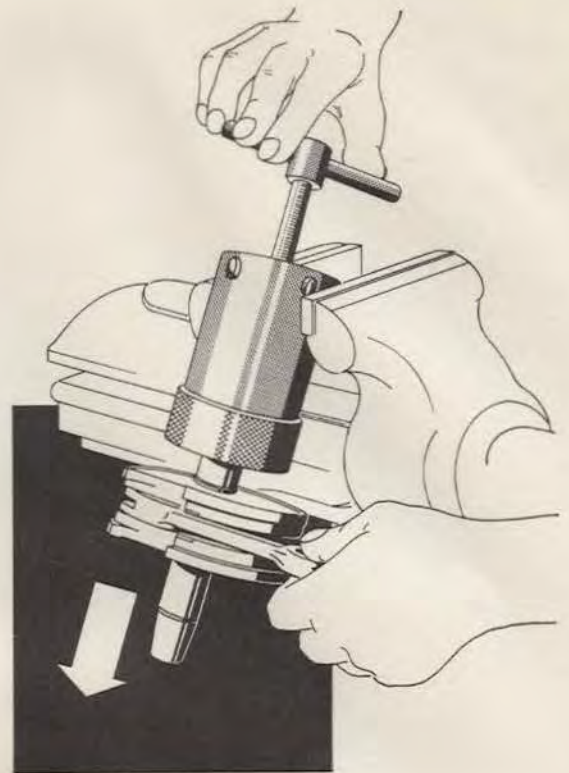
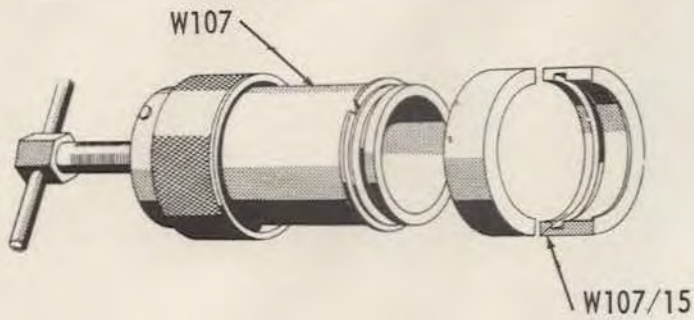

W79

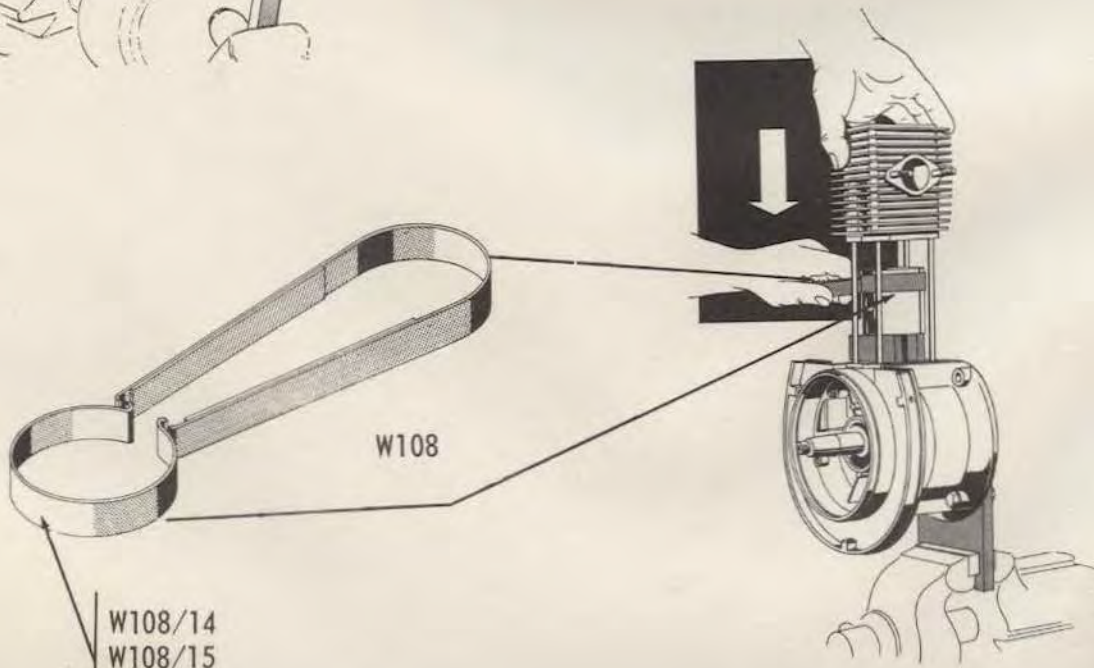

W108

W108/14

W108/15

W108/17

HIRTH TOOLS

W106

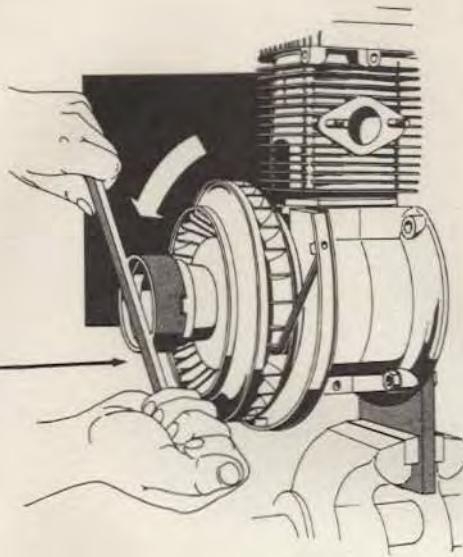
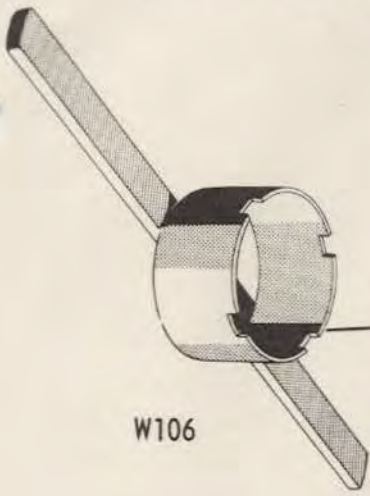

W113

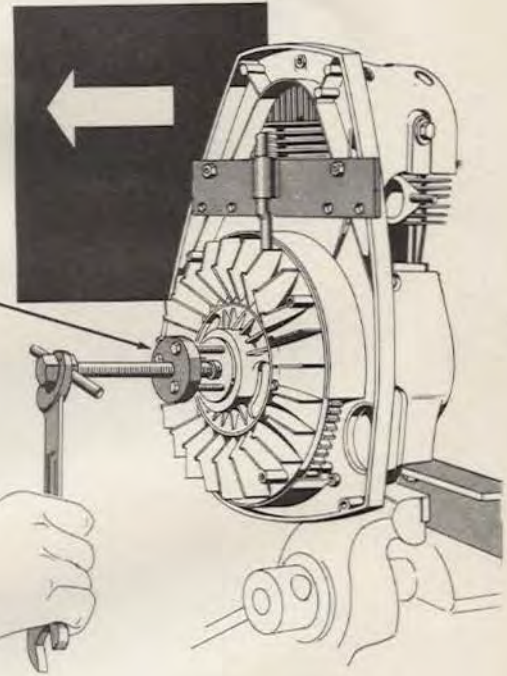
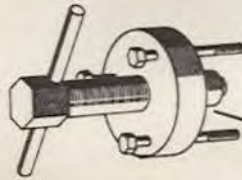

W109

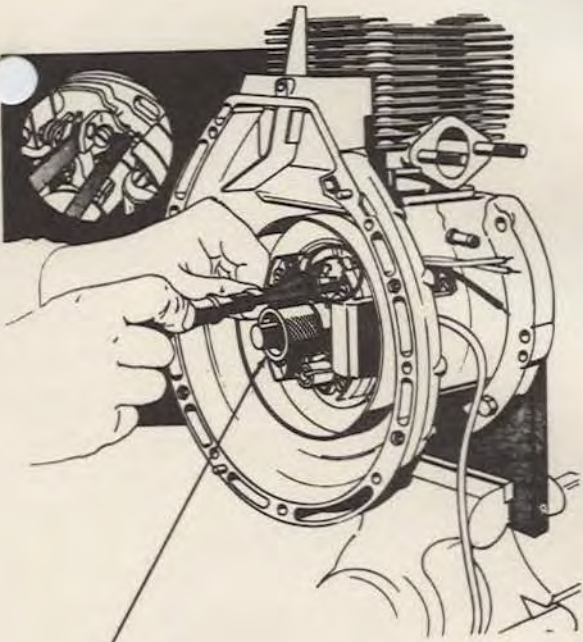
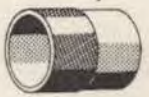

021.14/9

